

# SUMMER

## STANDARD FEATURES

- Hard wood frame, seat suspensions in reinforced elastic webbing
- Seat depth 60/102 cm - 24/40".
- Seat height 43 cm - 17".
- Armrest width 12 cm - 5".
- Armrest height 60 cm - 24".
- Seat cushions in polyurethane covered with wadding.
- Back cushions in polyurethane covered with feather.
- Armrest padding in polyurethane covered with wadding.
- Metal legs height 15 cm - 6" available in all customizing finish.
- Moveable back cushions on all the skus, corner unit included.
- Chaise longue include one C0138 throw pillow free of charge.
- All corner elements, sofas and elements with double seating module include one C0137 throw pillow free of charge.
- Stitching CUC 503B.

## CARATTERISTICHE STANDARD

- Struttura in legno e multistrato, molleggio seduta con cinghie elastiche.
- Profondità seduta 60/102 cm.
- Altezza seduta 43 cm.
- Larghezza braccio 12 cm.
- Altezza braccio 60 cm.
- Cuscini seduta in poliuretano rivestito in falda.
- Cuscini schienale in poliuretano con materassina in piuma.
- Imbottitura braccioli in poliuretano rivestito in falda.
- Piedi in metallo altezza 15 cm, disponibile in tutte le finiture presenti in collezione.
- Movimento del cuscino schienale su tutti gli elementi compreso l'angolo.
- Le chaise longue hanno il cuscino volante C0138 compreso nel prezzo.
- Elementi con angolo, divani ed elementi con doppio modulo seduta hanno il cuscino volante C0137 compreso nel prezzo.
- Cucitura CUC 503B.

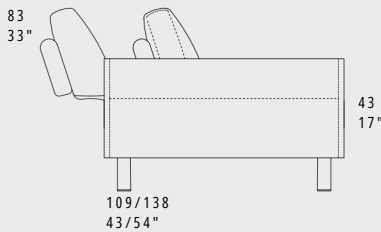

## NOTES

- Dimensions: the first figure shows sizes in centimeters, the second in inches.
- Mixing above groups (Y - J) will create sectionals with different seat widths.
- Corner piece E01 and EVT016 are odd pieces and can be used with all above groups Y - J.
- Suggested tables T265D, T266D, T267D.
- Suggested pillows C0137 and C0138.
- Suggested headrest PG021.
- Please advise covers for A and B.

## NOTE

- Dimensioni: la prima cifra indica i centimetri, la seconda cifra indica i pollici.
- Utilizzando elementi di famiglie diverse (Y - J) si avranno composizioni con sedute di larghezza diverse tra di loro.
- Gli elementi E01 ed EVT016 possono essere utilizzati indifferentemente con i gruppi Y - J.
- Tavolini consigliati T265D, T266D, T267D.
- Cuscini consigliati C0137 e C0138.
- Poggiatesta consigliato PG021.
- Si prega di specificare i rivestimenti A e B.

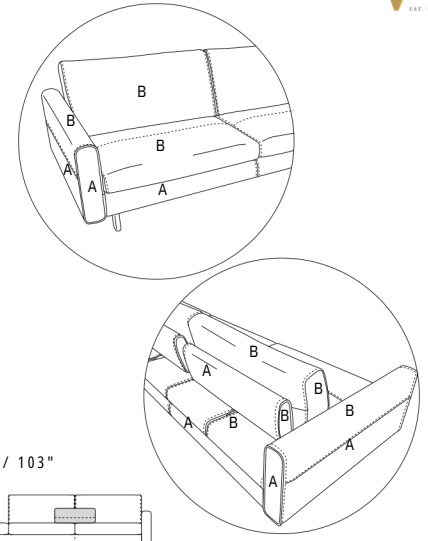
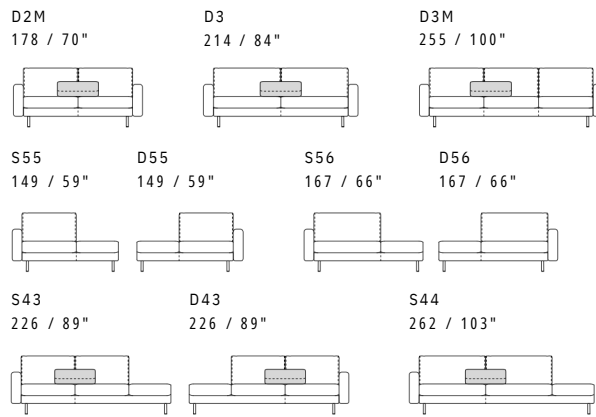

## Y all items in group Y have the same seat width / tutti gli elementi del gruppo Y hanno lo stesso modulo di seduta

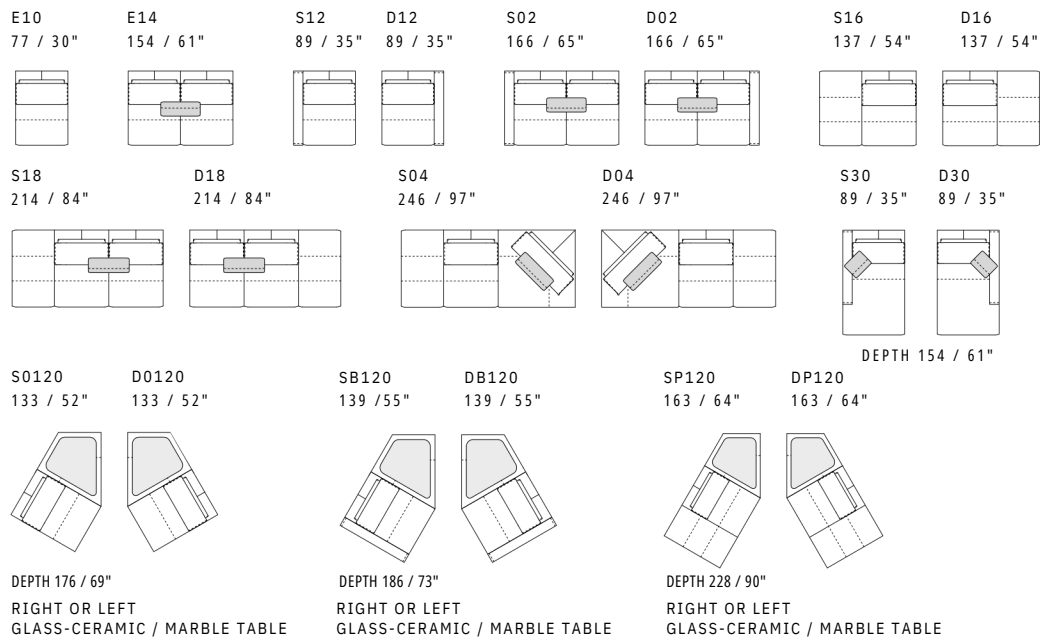

## J all items in group J have the same seat width / tutti gli elementi del gruppo J hanno lo stesso modulo di seduta

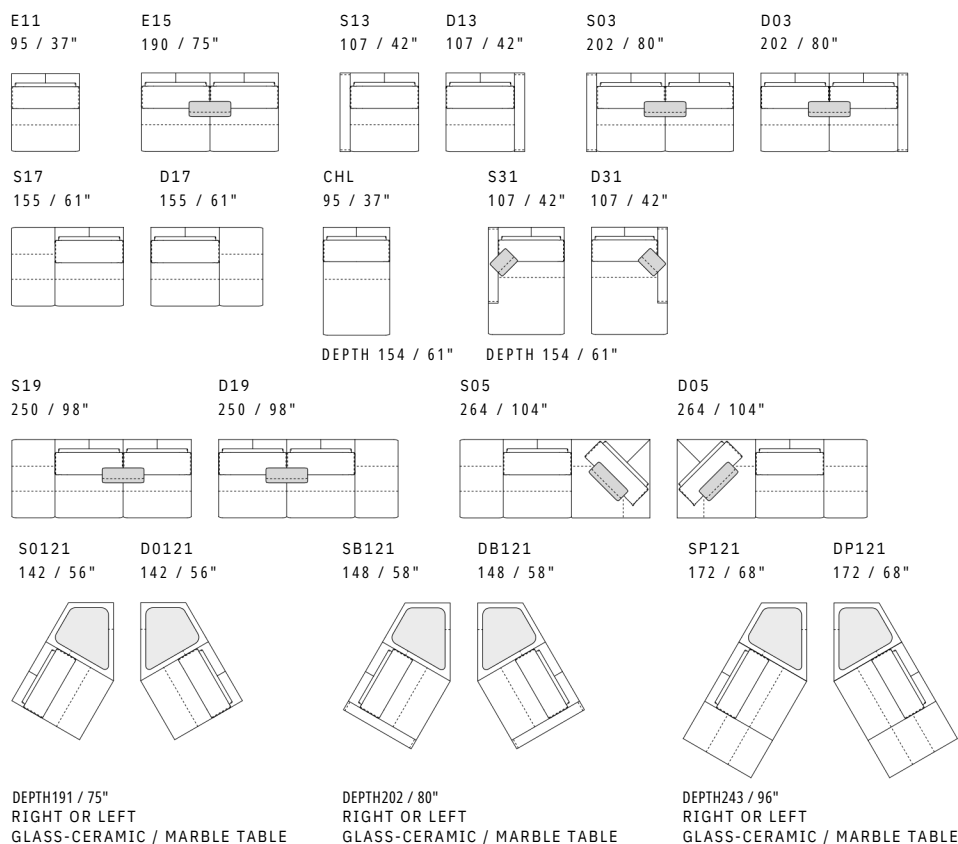

Tables with back lacquered glass (black or white), ceramic or marble top.

E01  
109X109 / 43X43"



EV4  
109X109XH.43 / 43X43XH.17"



EVT16  
95X109XH.46 / 37X43XH.18"

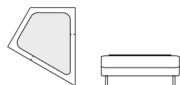

PG021 HEADREST  
DEPTH 13/5"  
26 / 10"  
65 / 26"



C0137 SUGGESTEDPILLOW  
55X30 / 22X12"

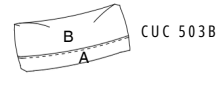

C0138 SUGGESTED PILLOW  
45X45 / 18X18"

