

REVIE

Standard Features:

- Advanced unidirectional suspension system
- Premium high-density, high-resiliency foam seat cushions
- Loose back and seat cushions
- Single-needle top-stitch
- Limited lifetime warranty on frame
- Quick-ship delivery

Options:

- Premium high-density, high-resiliency foam seat cushions encased in down
- Extra firm premium high-density, high-resiliency foam seat cushions
- Premium high-density, high-resiliency foam seat cushions encased in Trillium
- Wood arms and legs available in Dune, Ebony, Mink, or Oiled Ash Finish
- Solid Natural Walnut wood arms and legs available
- Contrasting cover available (two tone):
 - Color 1 - Body
 - Color 2 - Back/seat cushion

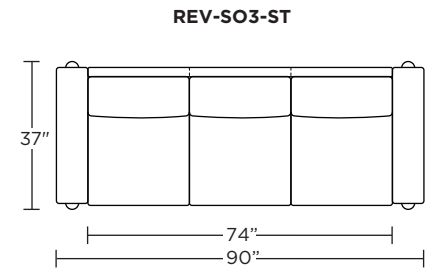
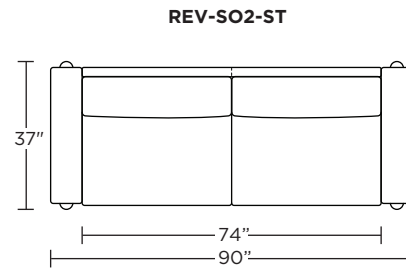
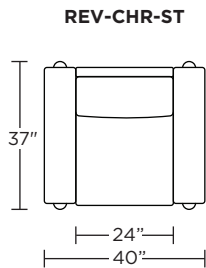
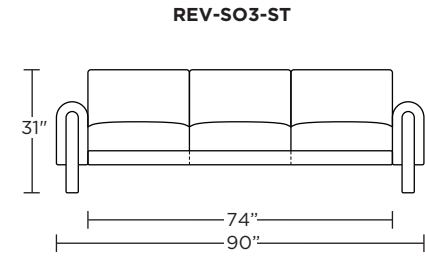
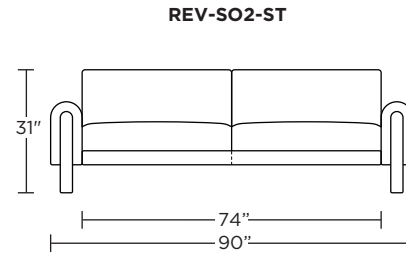
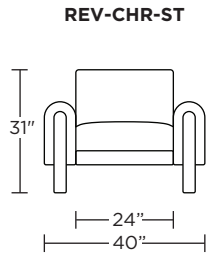

Leg height is 7"

Please use actual leather, fabric, Crypton®, Sunbrella® and Ultrasuede® swatches when specifying furniture as the colors shown may vary due to the printing process.

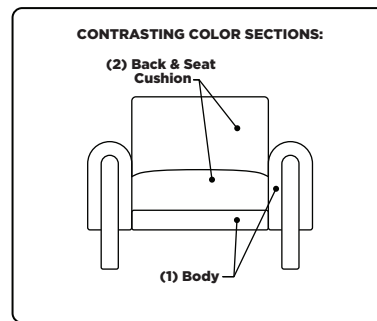
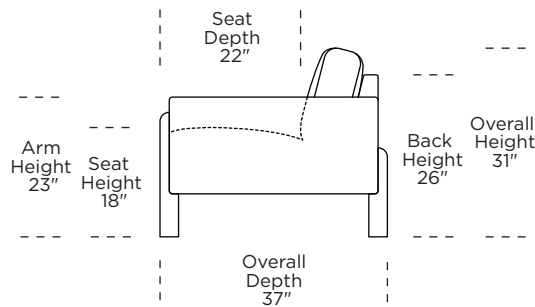

Scale: 1/4 inch = 1 foot
 All dimensions are approximate and subject to change.
 Specify components from the sitting position.

V01.14.26