

Standard Comfort Sleeper®

Features:

- Featuring the patented Ti any 24/7™ platform sleep system
- Room to stretch out with true 80 inches of bedroom-length sleeping surface
- Ultimate comfort on five inches of plush, high-density foam mattress
- Under-sofa dust covers keeps dust and dirt from ever touching the mattress
- Zero wall clearance
- Double-needle top-stitch
- High-density, high-resiliency foam seat cushions
- Loose back and seat cushions
- Limited lifetime warranty on frame
- 10-year mechanism warranty
- Quick-ship delivery

Mattress Options:

- HiPerform with Crypton® ticking
- Cooling Gel
- Tempur-Pedic®

Options:

- High-density, high-resiliency foam seat cushions encased in down and down back cushions available
- High-density, high-resiliency foam seat cushions encased in Trillium and Trillium back cushions available
- Bench seat cushion
- Tufted back and seat cushion decorative detail
- Wood legs available in Dune, Ebony, Mink, or Oiled Ash finish
- Ottomans available with casters
- Contrasting cover available (two-tone):
 - Color 1 - Body (dictates cost)
 - Color 2 - Back/seat cushions

Leg height is 2"

Please use actual leather, fabric, Crypton®, Sunbrella® and Ultrasuede® swatches when specifying furniture as the colors shown may vary due to the printing process.

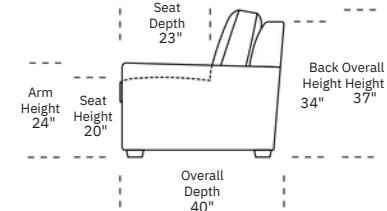

Note: Seat depth includes cushion overhang which may be up to 1"

SLEEPER OPTIONS:

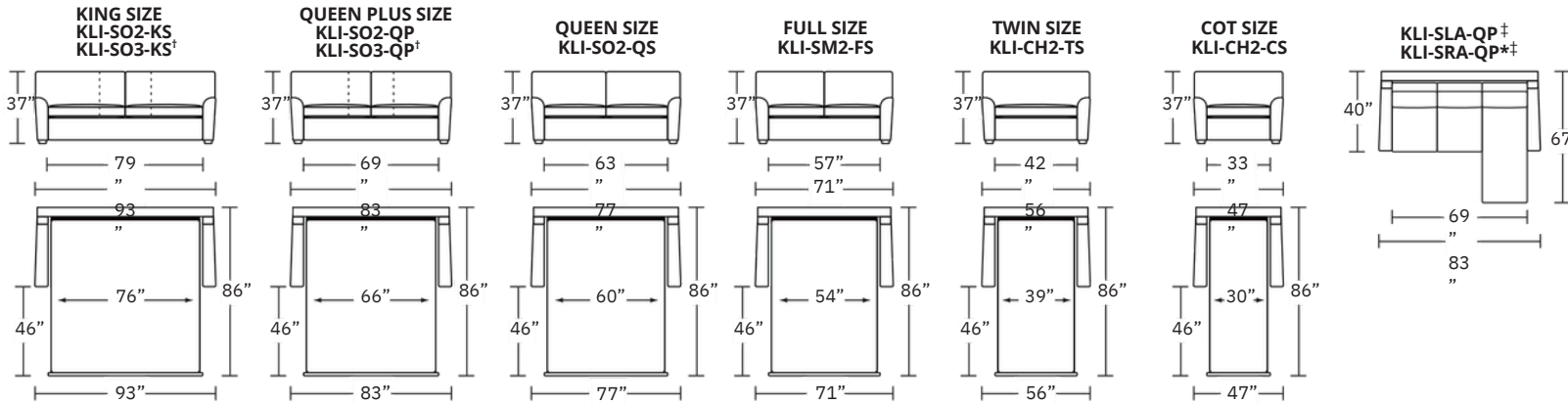

SECTIONAL OPTIONS:

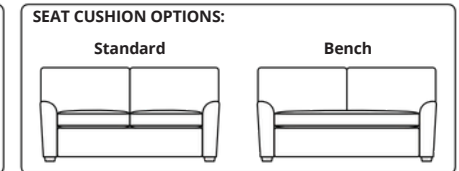
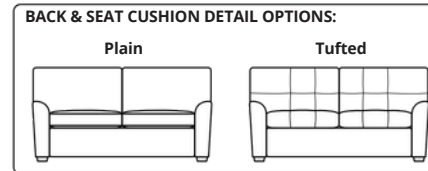
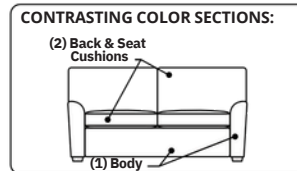
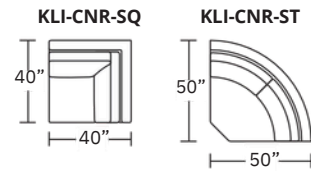
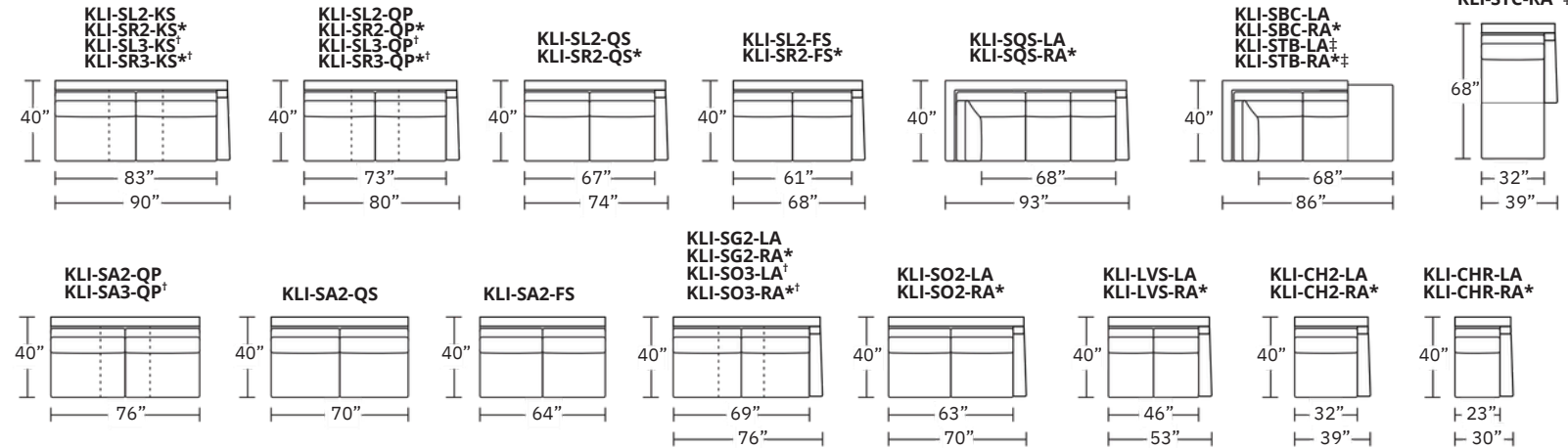

- * Picture shows left arm seated. Please specify left or right arm seated when ordering.
- All orders are in seated position.
- † Dotted lines for Queen Plus and King sizes indicates the number of seats.

- All dimensions are approximate and subject to change.
- ‡ Chaise lifts up to reveal hidden storage space. • Storage

NOTE: Microfiber fabrics such as SUEDELIFE and VEELIFE, as well as velvet fabrics including JENSON, REED, LOOME, and SURI, are not recommended for use on sleeper mechanisms. Higher pile fabrics may create additional friction, which can make opening and closing the mechanism more difficult. For a comprehensive list of non-recommended covers, please contact American Leather Customer Experience. Additional information is available on the fabric landing pages of our website or by scanning the swatch QR code.

Ti any 24/7™ Convertible mechanism, U.S. Patents #6904628, #8893323, #9468303, #9668585. Additional patents pending.



Standard Comfort Sleeper®
Stationary Features:

- High-density, high-resiliency foam seat cushions
- Loose back and seat cushions
- Double-needle top-stitch
- Zero wall clearance
- Limited lifetime warranty on frame
- 10-year mechanism warranty
- Quick-ship delivery

Options:

- High-density, high-resiliency foam seat cushions encased in down and down back cushions available
- High-density, high-resiliency foam seat cushions encased in Trillium and Trillium back cushions available
- Bench seat cushion
- Tufted back and seat cushion decorative detail
- Wood legs available in Dune, Ebony, Mink, or Oiled Ash finish
- Ottomans available with casters
- Contrasting cover available (two tone):
 - Color 1 - Body (dictates cost)
 - Color 2 - Back/seat cushions

STATIONARY OPTIONS:

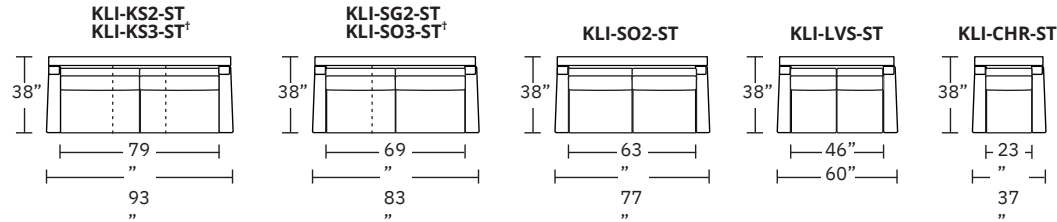

OTTOMAN OPTIONS:

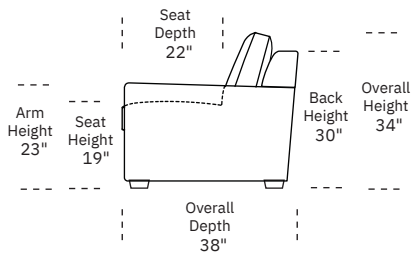
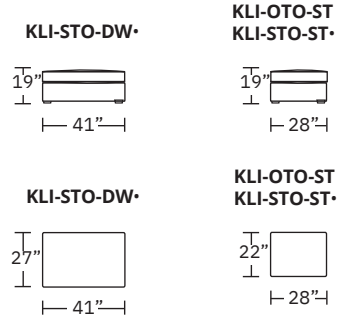

Note: Seat depth includes cushion overhang which may be up to 1"

<p>CONTRASTING COLOR SECTIONS:</p>	<p>BACK & SEAT CUSHION DETAIL OPTIONS:</p> <p>Plain Tufted</p>	<p>SEAT CUSHION OPTIONS:</p> <p>Standard Bench</p>
---	--	--

† Dotted lines indicates the number of seats.
 All dimensions are approximate and subject to change.
 • Storage

