

Standard Features:

- Advanced unidirectional suspension system
- Premium high-density, high-resiliency foam seat cushions
- Loose back and seat cushions
- Single-needle top-stitch
- Limited lifetime warranty on frame and suspension
- Quick-ship delivery

Options:

- Choice of decorative stitch detail – blanket, cross, double-needle, or zig-zag
- Contrasting stitch detail available in Bermuda Green, Beige, Black, Brown, Charcoal, Cream, Espresso, Gold Brown, Grey, Lemon, Midnight Blue, and Scarlet thread color
- Aluminum legs available in Gloss Black, Gloss Bronze or Polished Nickel finish

Please use actual leather, fabric, Crypton®, Sunbrella® and Ultrasuede® swatches when specifying furniture as the colors shown may vary due to the printing process.

COPENHAGEN

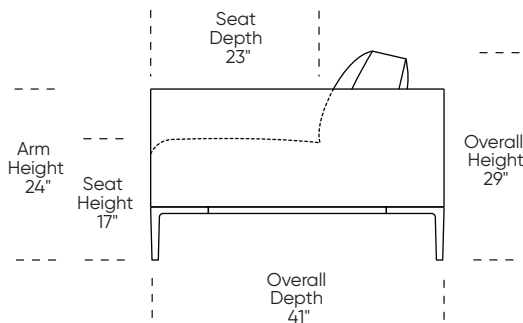
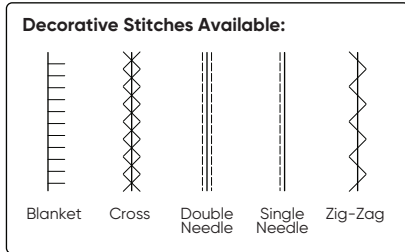
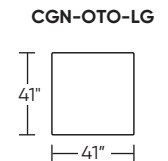
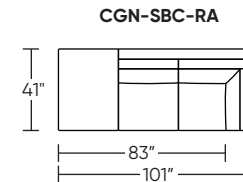
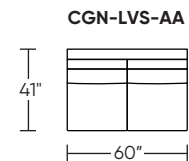
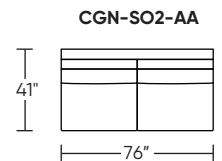
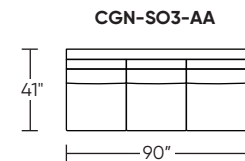
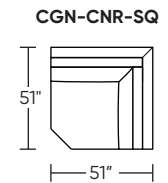
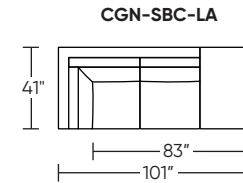
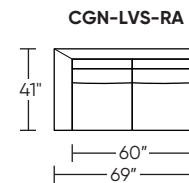
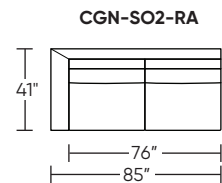
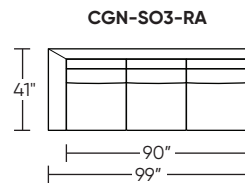
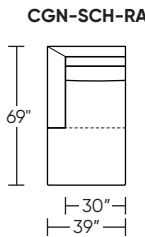
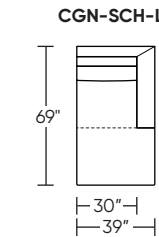
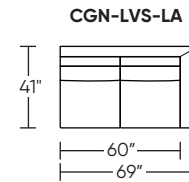
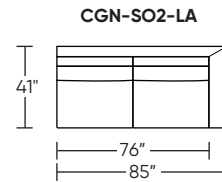
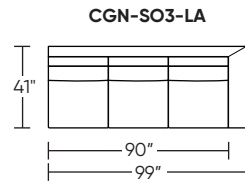
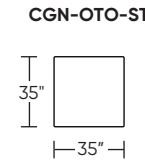
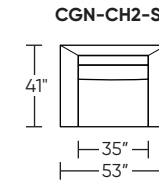
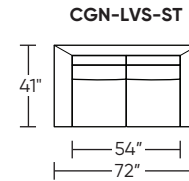
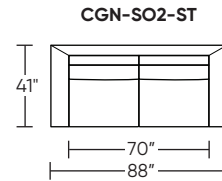
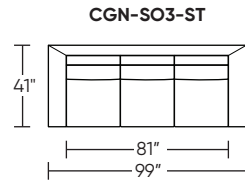
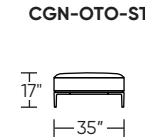
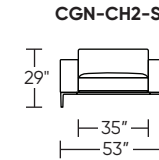
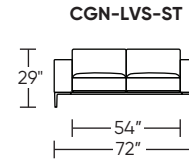
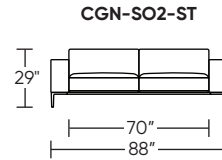
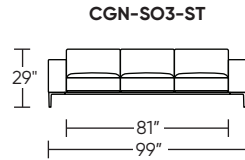

Note: Dotted line indicates seam on leather, Ultrasuede® and up the roll fabrics. Seams are eliminated with railroaded fabrics.

Scale: 1/8 inch = 1 foot
All dimensions are approximate and subject to change.
Specify components from the sitting position.